

# M4U TWM

TRUE WIRELESS MICRO PLANAR EARPHONES

## OWNER'S MANUAL



**psb**  
SPEAKERS

## INTRODUCTION

Thank you for purchasing a pair of PSB Speakers M4U TWM Earphones. Producing natural musical dynamics and precisely imaged sound, these high-fidelity earphones bring you closer to the music you love.

Engineered with 50 years of audio excellence and research, the M4U TWM delivers unmatched sound quality, all-day comfort and fold-and-go portability, for music enthusiasts and professionals. PSB's true-to-nature sound quality and stylish ergonomic design allow you to escape to a personal concert experience that travels anywhere with you.

## REGULATORY INFORMATION

Operating temperature range:	5°C – 40°C
Operating frequency range:	Bluetooth 2.4G
Input rating:	5V 1A
Earphone battery life:	8 hours per charge
Earphone charging time:	66 minutes
Case charging time:	2 hours
Number of full charges held in case:	3
Net weight of each earphone:	5 grams
Total weight of earphones in the case:	45 grams

M4U TWM is in compliance with the essential requirements and other relevant provisions of Directive 2014/53/EU.

Date of Manufacture: The second and third digits in the serial number indicates the year of manufacture; "21" is 2021.

Responsible Party:

Lenbrook Industries Limited. 633 Granite Court, Pickering, Ontario, Canada L1W 3K1.

Phone: (905) 831-6333, Facsimile: (905) 831-6936

The Bluetooth® word mark and logos are registered trademarks owned by Bluetooth SIG, Inc. and any use of such marks by PSB Speakers is under license.

The N-Mark is a trademark or registered trademark of the NFC Forum, Inc. in the United States and in other countries.



To prevent possible hearing damage, do not listen at high volume levels for long periods.

## OSHA GUIDELINES FOR NOISE EXPOSURE LIMITS

The Occupational Safety Health Administration (OSHA) has issued headphone usage recommendations for maximum daily exposure and sound pressure levels [measured in decibels (dB)]. A decibel is a unit of sound measurement that increases exponentially with volume. For example, conversational speech is typically around 60dB, and a rock concert in a stadium is often about 110dB.

<b>90dB</b>	8 hours
<b>95dB</b>	4 hours
<b>100dB</b>	2 hours
<b>105dB</b>	1 Hour
<b>110dB</b>	30 minutes
<b>115dB</b>	15 minutes
<b>120dB</b>	Avoid as damage may occur

## SAFETY INFORMATION

This device complies with Part 15 of the FCC Rules. Operation is subject to the following two conditions: (1) this device may not cause harmful interference, and (2) this device must accept any interference received, including interference that may cause undesired operation.

FCC ID: SVC-PSBM4UTWM

This device complies with Industry Canada license-exempt RSS standard(s). Operation is subject to the following two conditions: (1) this device may not cause interference, and (2) this device must accept any interference, including interference that may cause undesired operation of the device.

## RADIO FREQUENCY EXPOSURE STATEMENT FOR IC

The device has been evaluated to meet general RF exposure requirements. The device can be used in mobile exposure conditions. The minimum separation distance is 25mm.



## WARNING

Warnings or announcements may be unnoticed when you are using the earphones. Please be aware of ambient sounds while wearing the earphones and recognize them as needed.

- To prevent possible hearing damage, do not listen at high volume levels for long periods.
- These earphones should only be connected to a USB interface of version USB2.0 or higher.
- Risk of explosion if the battery is replaced by an incorrect type, dispose of used batteries according to the instructions.
- Be sure to read the Owner's Manual of the device that you want to connect to these earphones.
- Check the volume settings when using the earphones when in public places and ensure that you do not disturb people around you.
- These earphones are not guaranteed to work with all combinations of Bluetooth devices/mobile phones.
- These earphones do not support a connection with all Bluetooth devices/mobile phones.
- Bluetooth wireless technology can communicate up to approximately 10 m. Obstructions (people, metallic objects, walls, etc.) and radio wave conditions affect the actual range.
- The Bluetooth device that you want to connect with must support the same profile as these earphones in order to use the Bluetooth function. For details on profiles that the Bluetooth device is compatible with, see the Bluetooth device Owner's Manual.
- Due to features of Bluetooth wireless technology, playback of audio on the earphones is slightly delayed compared to the playback on the transmitting device.
- Do not use your earphones while driving.
- Remove the earphones immediately if you experience a warming sensation or loss of audio.
- Do not use mobile phone adaptors to connect these earphones to airplane seat jacks, as this could cause overheating and result in injury or property damage.
- The earphones and accessories contain small parts which may be a choking hazard. Not suitable for children under age 3.
- This product contains magnetic material. Consult your physician on whether this might affect your implanted medical device
- Use this product only with an agency approved power supply which meets local regulatory requirements (e.g., UL, CSA, VDE, CCC).
- Do not expose products containing batteries to excessive heat (e.g. from storage in direct sunlight, fire or the like).
- Long-term exposure to loud music may cause permanent hearing damage. To avoid personal injury when using the earphones for extended periods, the volume should be kept at the described levels in the OSHA Guidelines above.
- Fire or shock may occur should water or other foreign substances permeate inside the device.
- Do not attempt to modify this product as it could result in personal injury and/or product failure.
- Keep batteries out of reach of children.

At the end of its useful life, this product should not be disposed of with regular household waste. It should be returned to a collection point for the recycling of electrical and electronic equipment.



The materials can be reused in accordance with their markings. Through re-use, recycling of raw materials, or other forms of recycling of old products, you are making an important contribution to the protection of our environment. The following symbols on the packaging indicate the recycling mandate.

Your local administrative office can advise you of the responsible waste disposal location.

### INCLUDED ACCESSORIES...

Packed with your M4U TWM, you will find

- USB-C to USB-C charging cable
- Two sizes of silicone tips (plus one size already attached to the earphones)
- Charging case

### MAIN FEATURES...

Features apply to both earphones

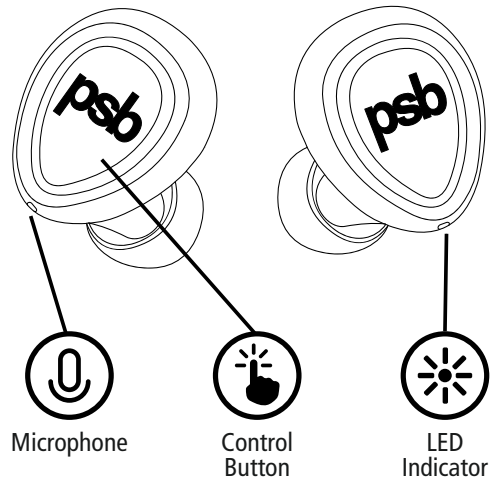

### OPERATION...

#### LED INDICATORS

PART	LED STATUS INDICATOR	DESCRIPTION
Left earphone and Right earphone	Left earphone - Alternately flashing Red and White	Unpaired Ready to be Paired
	Right earphone - Flashing White every 5 seconds	
	Both earphones are flashing White every 5 seconds	Bluetooth connection Paired to device
	Both earphones flash white continuously	Factory reset in process
Charging case (not connected to USB-C charging cable/ USB-C wall charger)	First and Fourth LED indicators flashing White	Earphones inside the Charging case are being charged.
	All four LED indicators are off (no light).	Earphones inside the Charging case are fully charged.
Charging case (connected to USB-C charging cable/USB-C wall charger)	One LED flashing White	Charging to 25% level
	One LED solid White and second LED flashing white	Charging 25% - 50% level
	Two LEDs solid White and third LED flashing White	Charging 50% - 75% level
	Three LEDs solid White and fourth LED flashing White	Charging 75% - 100% level
	All four LEDs solid White	Fully charged (100% level)

## POWER ON

There are two ways to Power up your M4U TWM.

### 1 With Charging Case

Preconditions:

- Both earphones are inside the Charging case.
- Charging case is connected OR not connected to a USB-C wall adapter (5V/1A universal charging adapter) with the supplied USB-C to USB-C charging cable.



Power ON your earphones by opening the Charging case.

### 2 With Left and Right earphones out of the Charging case

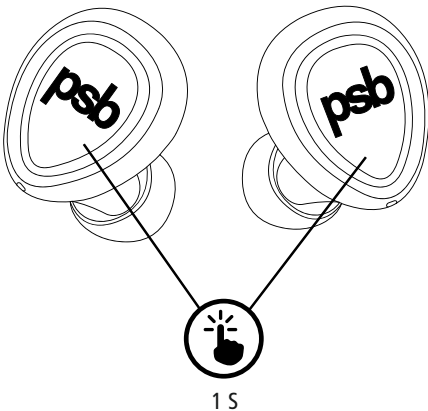

Press at the same time Left earphone Control button and Right earphone Control button for 1 second and then release both to Power ON your M4U TWM.

## INDICATORS

With both methods above, the LED indicator in each earphone will exhibit and manifest the following:

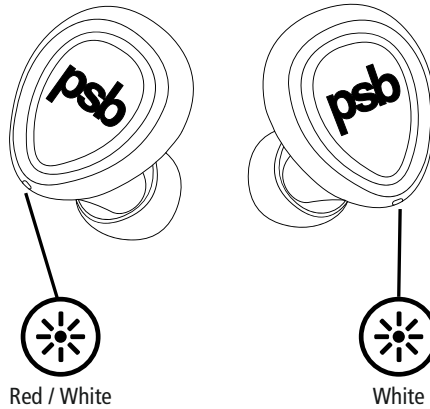

### LEFT EARPHONE

- Alternately flash Red and White

### Right earphone

- Flash White every 5 seconds

Audio prompt will occur with the following messages in succession –

- Message if earphones were previously paired or connected to a device - Power ON, indicate Battery Level and Connected (connect to last paired device)
- Message if earphones are not previously paired or connected to a device - Power ON, indicate Battery Level and Pairing

### NOTE

The M4U TWM will automatically shut down (Power OFF) if it is not paired to a device within 5 minutes.

## POWER OFF

With Left and Right earphones out of the Charging case

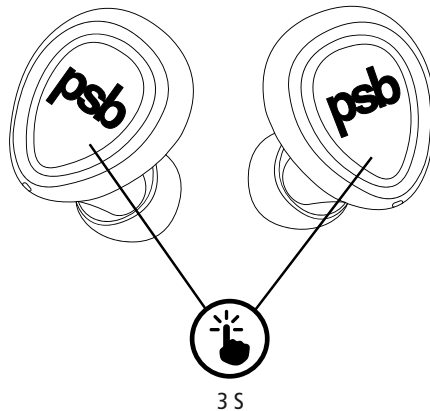

Press and hold at the same time Left earphone Control button and the Right earphone Control button for 3 seconds and then release both to power down your M4U TWM.

## INDICATORS

LED indicator in each earphone will exhibit and manifest the following:

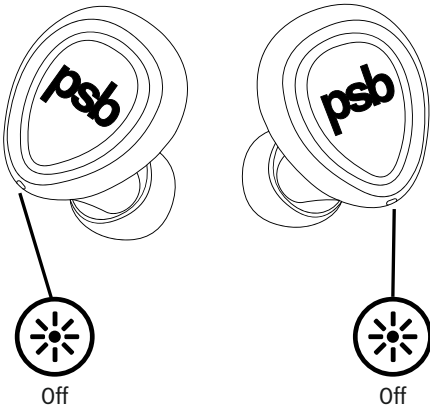

### LEFT AND RIGHT EARPHONES

- Off or no light

Audio prompt will occur with the following message - Power OFF

## WIRELESS PAIRING

Pairing is the process required to create a link between Bluetooth devices to allow wireless connection. You must pair a device with the M4U TWM to be able to make a BLUETOOTH connection for the first time.

Before you start Pairing operation, make sure that:

- The Bluetooth device is placed within 1 m (3 feet) of the M4U TWM.
- M4U TWM is charged sufficiently.
- M4U TWM is unpaired or disconnected.

### TO PAIR YOUR DEVICE

- 1 Turn on the Bluetooth feature on the source device.
- 2 Open the Bluetooth settings on the source device.
- 3 Power ON your M4U TWM. Left earphone will alternately flash Red and White while Right earphone will flash White every 5 seconds.
- 4 Select your M4U TWM from the source's device list. Once the M4U TWM's link has been established with the source device, both Left and Right earphones' LED indicator will flash White every 5 seconds to indicate Bluetooth connection is successful.

### TO UNPAIR YOUR DEVICE

- 1 Open the Bluetooth settings on the source device.
- 2 Unpair or disconnect by selecting your M4U TWM from the source device's paired devices list.

## VOLUME CONTROL

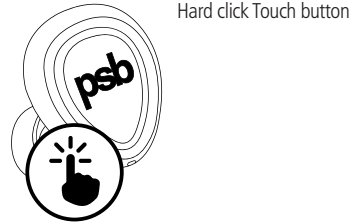

**Increase Volume level:** Press Right earphone Control button twice.



**Decrease Volume level:** Press Right earphone Control button three times.

## DURING PHONE CALL

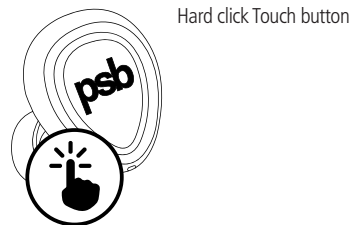

**Answer phone call:** Press Control button once on either earphone.



**End phone call:** Press Control button once on either earphone.



**Reject phone call:** Press Control button for 1 second on either earphone.



**Activate Phone's Voice Assistant:** During song playback or while powered up, press Control button for 1 second on either earphone.



1 S



**Mute Microphone:** Press Left earphone Control button twice.



X 2

## PLAYABILITY



Hard click Touch button



**Play or Pause song playback:** Toggle Control button once on either earphone.



X 1



**Skip back to previous song:** Press Left earphone Control button three times.



X 3



**Skip forward to next song:** Press Left earphone Control button twice.



X 2

## FACTORY RESET

Factory reset your M4U TWM if either Left earphone or Right earphone appears disconnected, lagging, malfunctioning or hang up. Factory reset also if you want to clear the pairing record or history of your M4U TWM.

Restore your M4U TWM to factory default settings by undertaking the following steps:

- 1 Press and hold at the same time Left earphone Control button and Right earphone Control button for 3 seconds and then release both to power down your M4U TWM.
- 2 Press and hold at the same time Left earphone Control button and Right earphone Control button for 10 seconds and then release both.
- 3 The LED indicators of both earphones will flash white continuously.
- 4 An Audio prompt will occur when your M4U TWM is ready for pairing. Left earphone will alternately flash Red and White while Right earphone will flash White every 5 seconds.

Your M4U TWM is now ready for pairing.

## NOTES

- Restoring M4U TWM to factory default settings will delete all Audioido profiles and user settings in the earphones and the earphone unpaired.
- Factory reset can also be initiated via the connected PSB Headphone App (Settings-Control-Reset Headphones).

## LISTENING...

With the volume set to low, turn on your audio source, find a comfortable listening level, and drift into a personal space filled with the sounds of your favorite audio/video collections.

## PERSONAL SOUND...

Audiiodo Personal Sound is a unique feature that corrects for your own personal hearing.

You must download the PSB Headphones app for your device in order to calibrate your M4U TWM with Audiiodo. Personal Sound calibration will not be possible without the PSB Headphones ones app.

Once you have the PSB Headphones app downloaded and your M4U TWM paired to that device, you are ready to set up your Audiiodo profile.



[psbspeakers.com/headphones-app](https://psbspeakers.com/headphones-app)



In the PSB Headphones app...

## CALIBRATION

The hearing calibration is meant to assess your hearing characteristics. To produce the most accurate results, we advise you to complete the calibration in a quiet place - the quieter, the better. If you're unsure whether you hear a tone or not, it is best to select NO.

Tap **START CALIBRATION** button to begin the hearing calibration.

The hearing calibration has now commenced. Select **YES** if you hear a tone or **NO** if you do not hear a tone. If you feel you cannot hear any tones during the calibration, make sure that you are connected to the earphones.

To quit the hearing calibration, tap the **X Calibration** in the top-left corner. If you choose to quit you will be redirected to the start page. You can redo the calibration at a later time, but no data will be saved.

## NOTES

- If you happen to connect the application to earphones that already have a profile stored on them, you will see the following Profile message - Save the Personal Sound "xxxxx"? The Personal Sound "xxxxx" was found in the connected earphones. Do you want to save it?. This means that a profile exists on the earphones you are now using but not on the app.
- To download/save the profile that is on earphones to your mobile application, select YES. If you select NO, the profile will not be downloaded to the app and cannot be accessed again unless the previous app and earphones are paired again.
- If for some reason your device gets disconnected, select **TRY AGAIN** to reconnect to it. To connect to a different device, select **ADD Headphones**.

## PROFILE NAME

After completing the hearing calibration, you can name your profile. The name must be at least one character long. You must create a name to proceed.

To rename or delete your profile, select **Personal Sound** from **Settings** menu. Then, from **Manage Profiles**, select the **Profile** to rename or delete.

## AGE

Select your age by dragging the cursor. Age affects how we hear, so its beneficial for us to collect this information in order to optimize the test process and the algorithms behind Audiiodo Personal Sound.

You must select an age to proceed. This information is not used for marketing purposes.

## GENDER

Select the icon that best describes your gender. Since gender affects how we hear, it is beneficial for us to collect this information in order to optimize the test process and the algorithms behind Audiiodo Personal Sound.

You must select a Gender icon to proceed. If you wish to decline answering, choose the icon in the middle. This information is not used for marketing purposes.

## MAIN MENU

Tapping the menu icon in the top-left corner will take you to the Main Menu. Selecting your calibrated PSB M4U TWM from the Main menu will take you to the Settings menu.

## PERSONAL SOUND

Under Settings menu, select **Personal Sound** to open your Profile List. At **Profile** section, there is an option to **Enable Personal Sound** - drag or swipe the slider icon to the right or to the left to enable or disable Personal Sound respectively.

On your visual hearing profile, the y-axis represents Sound Pressure Level while the x-axis represents Frequencies or Tone levels. Where the curves dip lowest is where the algorithm will compensate most.

To redo the hearing calibration or to add a new profile, tap the + in the top-left corner. This will take you to the screen where you can complete a new hearing calibration.



## BATTERY CHARGING...

### CHARGING THE EARPHONES

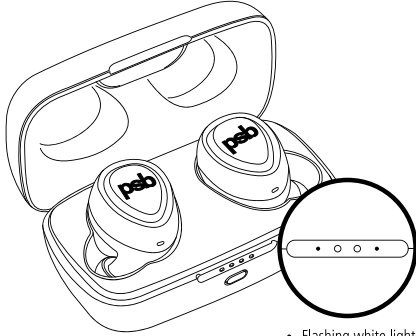

- Flashing white light
- Light off

- 1 Place both earphones in the Charging case and close. Charging will start automatically.
- 2 First and fourth LED indicators in the Charging case will flash White.
- 3 The LED indicators in the Charging case will turn off when the earphones are fully charged.

### CHARGING THE CHARGING CASE

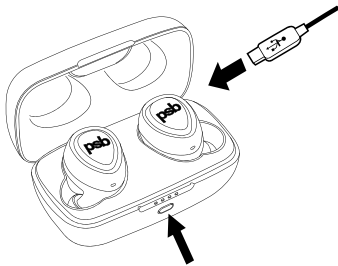

Remaining power: 100%	Remaining power: 75%-100%	Remaining power: 50%-75%
Remaining power: 25%-50%	Remaining power: <25%	Remaining power: 0%
• White light	• Flashing white light	○ Light off

Plug in one end of the supplied USB-C charging cable to the Charging case and the other end of the USB-C charging cable to a universal 5V 1A USB-C wall adapter (not supplied).

- 1 The LED indicators in the Charging case will illuminate sequentially from left to right during charging.
- 2 All four LED indicators will be illuminated solid white when the Charging case is fully charged.

## CLEANING...

The earbuds are IP65 rated, making them sweatproof, water resistant, dustproof and well-suited for any active endeavor.

For safe, sanitary use, it is essential to maintain and clean your M4U TWM earphones periodically. However, excessive cleaning may cause damage and jeopardize the longevity of the product. When not in use, always store earphones in the Charging case and store in a clean and dry environment. Avoid storing in extreme heat or cold temperatures and humidity and avoid exposure to liquids.

For regular cleaning, use a slightly damp cloth and gently clean each, then use a dry cloth to remove any residual moisture.

## WARNING

Liquids or cleaning solvents can cause irreparable damage to the electronics inside your earphones. The M4U TWM warranty does not cover such damage.



[www.psbSpeakers.com](http://www.psbSpeakers.com)

©2023 PSB SPEAKERS

A DIVISION OF LENBROOK INDUSTRIES LIMITED

PSB and the PSB logo are trademarks of PSB Speakers, a division of Lenbrook Industries Limited. All rights reserved.  
No part of this publication may be reproduced, stored or transmitted in any form whatsoever without the written permission of PSB Speakers.  
While every effort has been made to ensure the contents are accurate at the time of publication, features and specifications may be subject to change without prior notice.